



243-306 HP

# MF ACTIVA S

7345/7347



FROM MASSEY FERGUSON



**Page 08**  
Choose your table



**Page 12**  
Threshing and separation



**Page 14**  
Grain tank, shaker shoe and residue management



**Page 20**  
Hand shaped controls for easy operation



**Page 22**  
Operation from your fingertips

# Contents

- 04 Quality manufacturing
- 06 Flexibility is the key
- 08 Choose your table
- 10 Pure Gold from Massey Ferguson
- 12 Threshing and separation
- 13 MCS versions - Two systems in one
- 14 Grain tank, shaker shoe and residue management
- 16 The Proline cab
- 18 Your control centre
- 20 Hand shaped controls for easy operation
- 22 Operation and control from your fingertips
- 24 Good design makes for easy work
- 26 How much importance do you place on your combine engine?
- 27 Parts. There when you need them.
- 28 Specifications
- 30 3D walk around



## Page 26

How much importance do you place on your combine engine?



## Page 30

3D walk around



## Breganze, Italy

Harvesting Centre of Excellence for Massey Ferguson, Home of precision engineering and manufacture.

This is where each machine comes to life, where every tiny piece comes together to produce machines of incredible capabilities. The Breganze combine factory lies within the beautiful province of Vicenza in Italy. Like the various Massey Ferguson production plants around the world, the Breganze factory has an extensive and proud agricultural manufacturing history.

The Breganze factory manufactures mid-range, hybrid and 8-walker combine harvesters for Massey Ferguson, for distribution in Europe, Africa and the Middle East. This modern facility covers 25 hectares and employs over 600 people. Produced using the latest technology, combine harvesters at the Breganze plant are built to the highest specification and quality by a very dedicated team.

Today Breganze produces combines with a range of threshing technologies. All combines are complemented by a range of FreeFlow or PowerFlow headers, available in different sizes, that are designed to maximise harvesting speed and efficiency while minimising crop loss.





# MF ACTIVA S

# Flexibility is the key

Designed to offer choice for farmers, the new Massey Ferguson Activa S combine range has features for performance and practicality. The operator has been given new higher levels of comfort in this class while offering simple straightforward choices of specification.

Medium to large farmers often have a variety crops to combine and each machine needs to offer the best selection of settings to get the output required with a good clean sample. Surveys show that the operators of these machines need practical solutions to do this and value simplicity and comfort.

Model	Max power (hp/kW)	No. of straw walkers	Grain capacity (litres)
MF ACTIVA S 7345	243/179	5	8600
MF ACTIVA S 7345 MCS	243/179	5	8600
MF ACTIVA S 7347	306/225*	6	8600
MF ACTIVA S 7347 MCS	306/225*	6	8600

\*includes 30 hp boost

## A sound investment

- Practical design gives a mix of technology and functional features that are simple to work with and to get the best from in the field where time is of the essence
- Low operating costs, excellent fuel economy and simple servicing
- New Proline cab offers premium comfort for drivers
- Quality sample from grain through to straw, thanks to gentle threshing and intensive separation
- MCS versions offer flexible 2 in 1 threshing system for all crop capabilities with easy setting
- High capacity headers choice, designed to work in all conditions and all crops – PowerFlow or FreeFlow being the professionals' choice

# Choose your table

Head first feed – start well, finish well - your header is critical to how well your combine performs. With a lifetime of experience, Massey Ferguson offers you a choice of its premium PowerFlow table or high capacity FreeFlow tables. Both have features for productivity like Automatic Reel speed and advanced table height control.



FreeFlow

## FreeFlow up to 7.6 m



Combined multicoupler is standard for quick table dismount.



The Schumacher knife is the best performing knife in the business at 1,254 cuts a minute. Self-cleaning and consistently sharp, this keeps the crop moving in tough conditions.



Full width auger fingers on the FreeFlow table increase auger throughput, ensuring positive and fast feed into the main crop elevator.



The Power Feed Roller (MCS Version only) at the front of the main crop elevator gives a consistent crop flow from the table into the main crop elevator. It can be reversed simply and effectively from the cab.



PowerFlow

# PowerFlow up to 6.8 m



The optional rape auger for the PowerFlow table increases the flow of tall crops into the elevator thereby increasing the output considerably. Two electrical side knives complete the rapeseed kit.



The knife is a massive 1.14 m from the table auger, so vision and performance are optimum. The rugged PowerFlow belts power the crop away from the knife and into the main crop elevator at a consistent speed. The belts also deflect stones rather than taking them into the machine where they might cause damage.



AutoLevel table control is standard with cutting height control. Smooth transition from one side to the other maintains a constant cutting height with sensitivity, the mark of quality hydraulics and electronics working together.



www.masseyferguson.com

**PURE GOLD**



# FROM MASSEY FERGUSON

- thresh it gently and correctly and your profits increase



## Threshing and separation

The flexible heart of the combine. Equipped with a robust, high-inertia cylinder and a heavy-duty concave, these machines can handle crops easily.

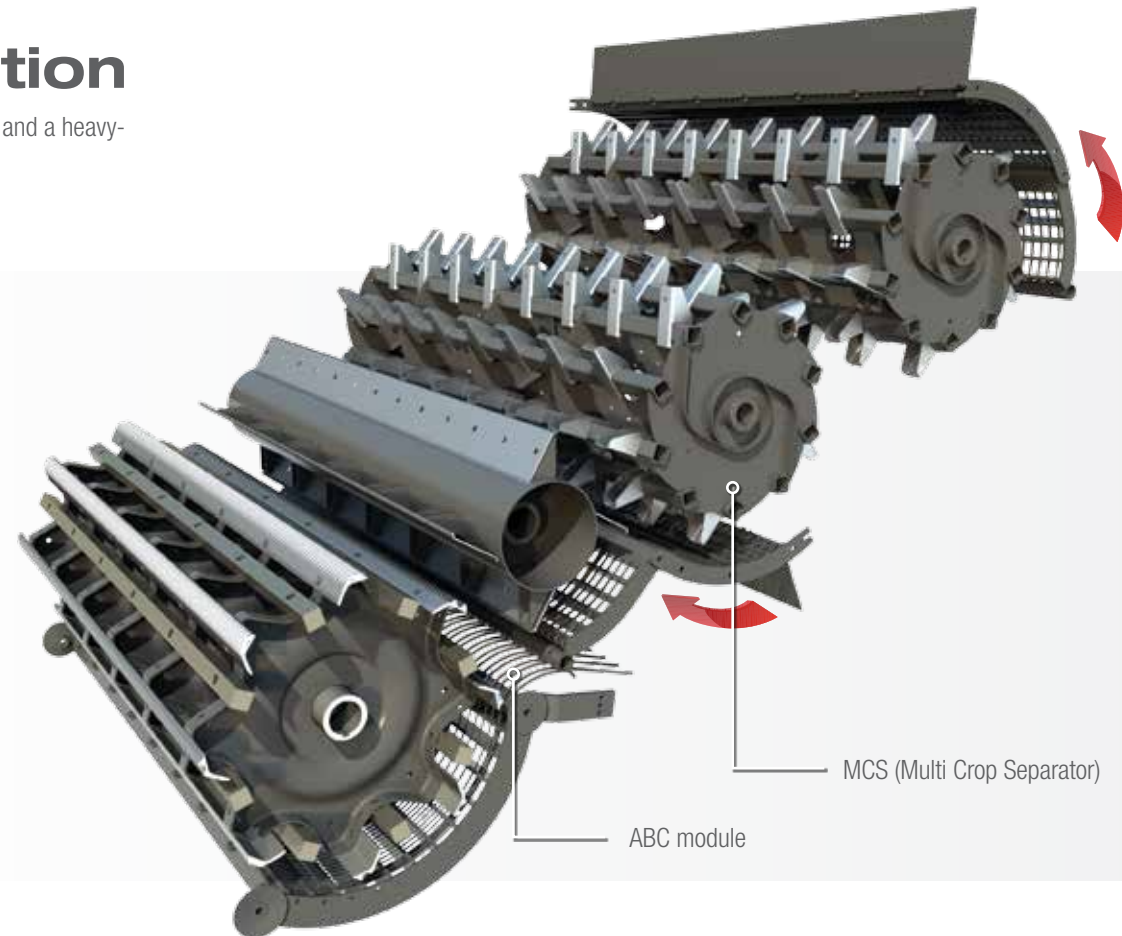

The threshing drum has added weight in the form of ballast bars to increase the inertia behind the rasp bars as they thresh the heads. This reduces load on the drives, power requirement and fuel consumption.

The concave has differentiated wire spacing, and the rear section of the concave has half as many wires as the front section. This principle provides the optimum balance between high threshing capacity and good grain flow through the concave. The concave, front and rear, can be set from the cab independently in order to optimise the threshing quality.

### Two versions of the combine are available –

- Concave with the ABC module (an extension to the separation area of the concave and is adjustable in three positions)
- Concave with the ABC module, Power Feed Roller and MCS (Multi Crop Separator)

## MCS versions – Two systems in one

The Multi Crop Separator provides a massive separation area to remove as much grain as possible before it reaches the walkers.

The MCS (Multicrop Separator) has one unique feature that sets it apart from the rest, the ability to rotate the concave up over the top of the rotary separator when it is not required. The MCS concave is moved electrically, requiring no tools. This makes it possible to optimise machine performance in dry conditions reducing the load on the shaker shoes and considerably improving the straw quality.

A full maize kit can be fitted including a maize concave. For this application the chopper speed reduction kit comes as standard with the grain version.

To increase versatility and save time Massey Ferguson can offer an optional Sectional concave which is designed to harvest a multitude of crops. The conversion time when moving from small grain to large seeded crops such as Soya, Maize and Sunflower can be completed in minutes rather than hours.

Or a Universal concave with removable elements can be fitted if required.



## Special Applications Rice

A special Rice cylinder / concave version can be ordered with unique peg and tooth design, specifically for separation in tough conditions. Additional components are also fitted which have extra wearing capability. This includes the grain augers, elevators and the MCS teeth. These specifications coupled with self-lubricating tracks and tables specific with hard wear components provide a versatile machine for rice as well as grain and maize.

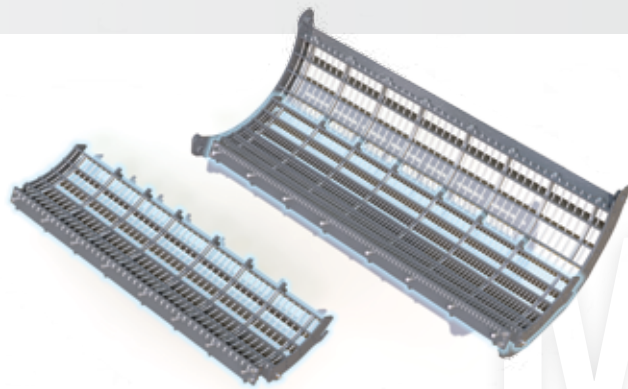
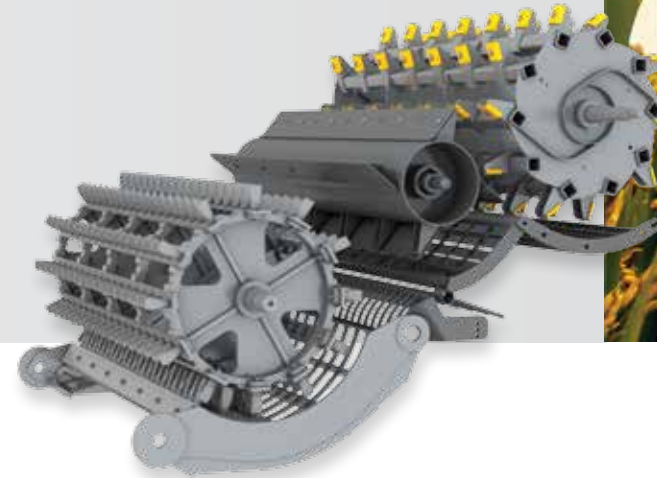

# MF ACTIVA S

# Grain tank, shaker shoe and residue management

The quality of your sample affects your margin. Special attention to the shaker shoe with the use of high capacity cleaning sieves gives you the best quality sample from the field.

The grain tanks have a high capacity of 8,600 litres, while the unloading rate of 105 l/sec (MCS) is fast for quick unloading. The turret auger can cope with the highest of trailers in the field or on the road. An optional yield monitor and moisture sensor – the Ceres 8000i with integral SD card reader – can be fitted.



The long straw walkers feature four steps with 'active walls'. The 21 cm high, vertical sections of the walker steps are made up of permeable grids. These are the highest for any conventional combine. The front steps of the straw walkers are reinforced for maize.



The sieve profile is the key to shaker shoe performance. The high performance sieves are specially designed with vertical tags which improve the sample and allow you to open the sieves wider for greater throughput. The practical design also allows one person to remove and clean the sieves easily between crops.



The good grain and return auger are reinforced where there is a direction change for long life and durability. This is particularly good for maize harvest where the wear from the crop is accelerated or in other conditions of high wear. For economy the elevator bottoms can be unbolted individually and replaced easily and less expensively.

The straw chopper is specifically designed to provide chopping and spreading performance suitable for farmers using reduced tillage operations. The knives are serrated to give a clean chop and reduce the power requirement. The fully adjustable stationary knives and straw chopper hood ensure complete control over the quality and spread of the chopped straw. Electrical deflectors for the straw chopper are available as an option. This allows the straw to be directed away from the uncut crop if required.



An adjustable dimple plate is standard to make sure straw is chopped consistently.



A twin rotor multi adjustable chaff spreader is available as an option. For those that require straw, the threshing system is gentle and leaves the straw in perfect condition for baling feed and bedding straw or producing products for power generation.



For those that require straw, the threshing system is gentle and leaves the straw in perfect condition for baling feed and bedding straw or producing products for power generation.

# WFF ACTIVAS







**Designed for you to get the best from your machine day or night**

## **Introducing the Proline cab**

An excellent cab environment is the key to getting the best performance from the machine and operator. Excellent visibility with ergonomically placed controls makes the workload easier and more productive. Intuitive menus on the TechTouch 2 terminal provide information at a moment's notice and active warning systems protect your investment.

# Your control centre

Fundamental elements of good cab design include space, comfort and visibility. The new Proline cab offers all of these, ensuring complete operator comfort at all times. Visibility is excellent with a panoramic view for the operator including header, stubble, unloader and the rear with large electrically adjustable mirrors.

The cab comes with a host of features you would expect in an operator environment of this quality.

- Fully automatic air conditioning including heating
- Air suspension seat
- Electrically adjustable heated mirrors
- Instructor seat with cooler and storage box
- Excellent sound insulation means you work in quiet comfort
- Safe and easy to use cab steps



View your stubble scenery



Clear view of the unloader auger when in operation



The TechTouch 2 Terminal right at hand



Enhanced visibility through the mirrors to the rear wheel



Main controls from the operator's eye



## Hand shaped controls for easy operation



- 01 Reel lift/lower
- 02 Reel fore/aft
- 03 Automatic stop
- 04 Cutting header up/down
- 05 Cutting header level left/right
- 06 Unloading engagement
- 07 Unloading tube open/close
- 08 Automatic header control engagement



- 01 Engine speed setting
- 02 Thresher engagement
- 03 Cutting header engagement

### Power Grip lever

The new control interface for the operator falls naturally to hand – the PowerGrip multifunction lever sits on top of the armrest which houses all the switches for the commonly used controls. The armrest can be raised and moved forward to suit the driver using two levers on the right-hand side of the console.

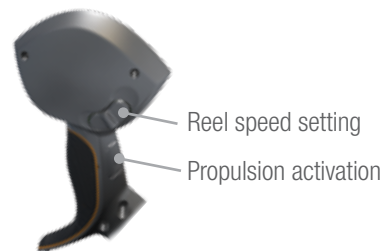

### Power Grip armrest

The right-hand armrest is the central operating unit where the key engagement switches sit with the throttle control. Designed with a large soft pad to cushion the arm during a long day allows for maximum comfort. As the propulsion lever does not need to slide it makes operation far less tiring than conventional set-ups.

**TechTouch 2 Terminal**

Perfectly in view and reach is the TechTouch 2 terminal which provides all the relevant performance information for setting the combine. The touch screen controls with clear definition are easy to use and adjust.



- 01 Drum speed setting
- 02 Front concave clearance
- 03 Rear concave clearance
- 04 Fan speed setting
- 05 Upper sieves setting (optional)
- 06 Lower sieves setting (optional)
- 07 Straw chopper deflector L/R (optional)
- 08 Grain tank cover open/close
- 09 Vertical knives engagement
- 10 Road mode

**Keypad**

The membrane keypad is located directly on the right side of the armrest and is used to operate the principle combine functions. The soft, raised keys lead directly to the individual menus on the TechTouch 2 terminal.



# MF ACTIVA S

# Operation and control from your fingertips

The new TechTouch 2 terminal is the control centre for all key performance operations, it has a touch screen, and you can use the unique safety navigator to display the screen you require.

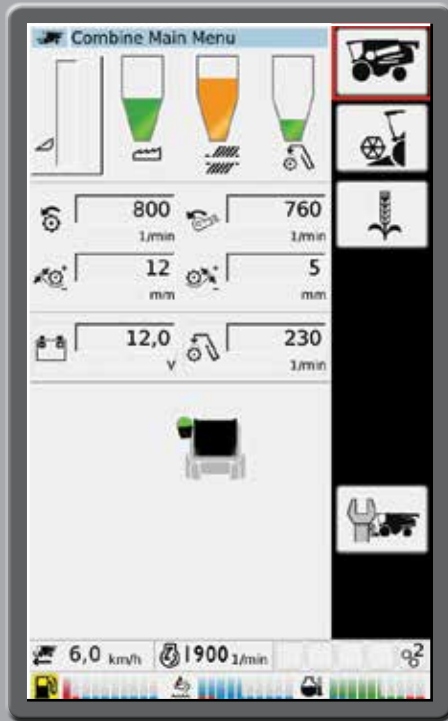

## Working Screen

As soon as the combine is ready to harvest the Combine Information Screen is displayed. With colour indicators for table height, performance and return volumes, it's easy to monitor with a quick glance. When in operation, audible and visual alarms are displayed to protect the combine.



## Dashboard

At the bottom of the screen there is a permanent dashboard showing forward speed, engine rpm, fuel capacity and the transport gear.



## Automatic Setting

Automatic setting can be actioned through various menus for a wide variety of crops, which saves time and energy. For each crop there are further combinations (for example when the conditions are damp or dry) that can be stored.

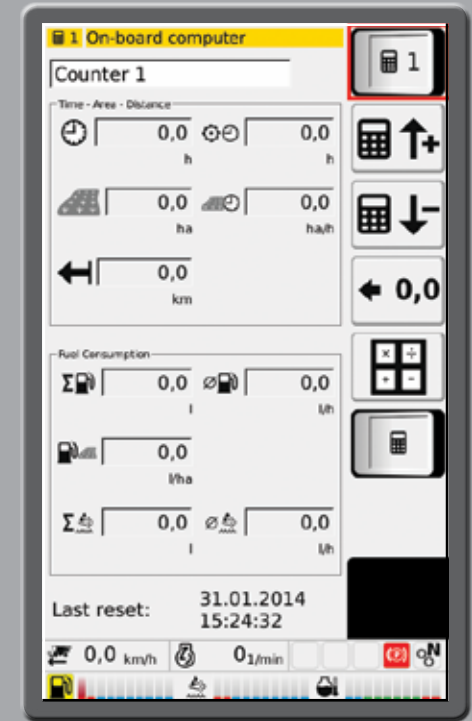

## Trip counters

The TechTouch 2 terminal also contains a series of logs that record hours, hectares, fuel and tank fills in various modes. The operator can reset these at any time or save versions if he wants to return to a field and continue the logs. This is useful for field records and those that combine for others.

### Simple to read and use

- The easy-to-read colour touch screen can be adjusted for each operator, which choices for what should be displayed.
- Clear uncluttered display makes the job of interpreting the information very easy – warnings are shown clearly as a priority.
- Automated crop settings – up to 10 variations of crop settings can be added within the menu on the TechTouch 2 terminal, which when selected will alter the combine automatically.



# Good design makes for easy work

Getting the best from well-designed features on a day-to-day basis.



Checking and cleaning the air filter



Safe and simple access for radiator cleaning



One piece panels with lights allow for quick inspection access with lights for night work



Easy refueling - both tanks are located next to each other for easy access



Ladder rail makes inspection easy and safe



Easy change from chopping to swathing for bales



# Time to harvest

Night working package includes H9 high intensity lights for all-round excellent visibility late into the evening.



Six adjustable H9 working lights

Optional working light package with two row finder, two stubble and two rear lights

Four fixed H7 lights and two H9 working lights

## How much importance do you place on your combine engine?

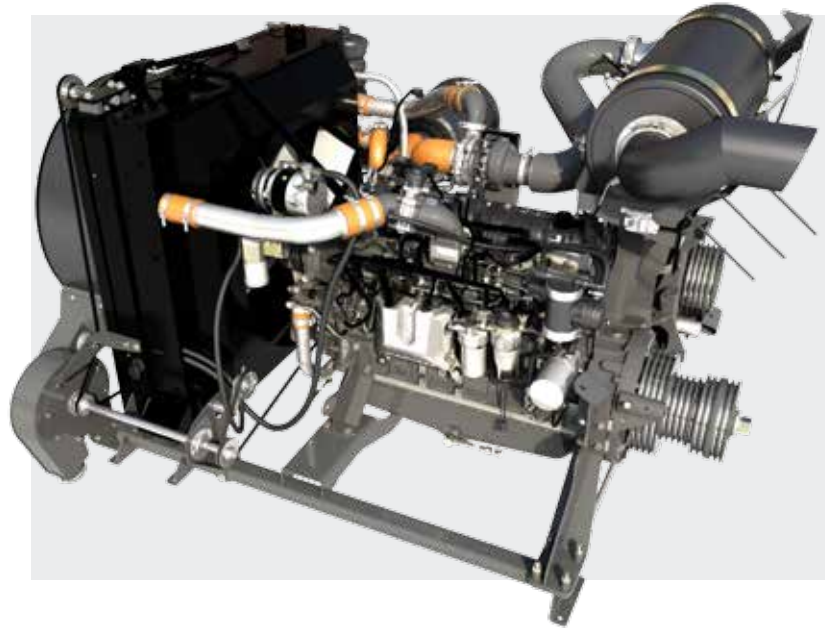

We can promise you that your AGCO POWER engine has been designed to match the latest emission regulations using SCR technology meaning that actually it has one of the most advanced designs on the market. It's better for the environment and running costs will be one of the lowest in the business. These are important parameters.

Also it's important how it performs – we can tell you that fuelling is designed to give a flat torque curve, one that a combine needs to give a constant delivery under load despite the conditions. This coupled with the low friction drives we use will give you incredibly low fuel consumption per tonne and excellent fuel economy.  
(low regulation fuel versions available)

For the higher output 6 walker we have added an automatic 30 hp boost facility for unloading – enabling you to maintain output in tough conditions.

**We think it will make a significant difference to you!**

## Total Support. There when you need it.

Massey Ferguson and its Distributors and Dealers are always prepared and ready to put in the extra mile to support your purchase.



Agriculture can be a tough business, that's why we make sure that you can get support whenever you need it and at crucial times of the year. Our Dealers are committed to finding the right product for you and then supporting you with the best service, parts provision and backup. You'll be part of a dedicated family of highly skilled specialists who make it their business to give you genuine, top quality service support.

We understand farming and are aware of the challenges each individual faces, therefore our Dealers can help you to plan for a successful future. Ask your Dealer about our finance plans, which can include leasing, hire purchase, contract hire and loan facilities.

You can also secure your assets with a manager Service and Extended Warranty Plan. manager Service and Extended Warranty Plan\* is a complete package aimed at providing total care for your combine including routine maintenance, repair cover and full AGCO backed warranty.

\*manager Service and Extended Warranty Plan may not be available or may be market dependant. Please contact your Massey Ferguson Dealer to check availability in your area. Terms and conditions apply.

# Specifications as standard



	ACTIVA S 7345	ACTIVA S 7345 MCS	ACTIVA S 7347	ACTIVA S 7347 MCS
<b>Table and main crop elevator</b>				
Cutting widths available on FreeFlow (m)	4.80 to 7.60	4.80 to 7.60	4.80 to 7.60	4.80 to 7.60
Cutting widths available on PowerFlow (m)	5.50 to 6.20	5.50 to 6.20	5.50 to 6.80	5.50 to 6.80
Table and elevator reverser	●	●	●	●
Automatic reel speed	●	●	●	●
Automatic cutting height control table	●	●	●	●
AutoLevel table	●	●	●	●
Power Feed roller	-	●	-	●
<b>High-inertia cylinder</b>				
8 + 8 ballast bars	●	●	●	-
Width / diameter (mm)	1340 / 600	1340 / 600	1600 / 600	1600 / 600
Speed range (rev/min)	380 to 1100	380 to 1100	430 to 1210	430 to 1210
<b>Concave</b>				
ABC concave (degrees)	14	14	14	14
No. of bars	12	12	12	12
Wrap angle (degrees)	120	120	120	120
Area (m <sup>2</sup> )	0.83	0.83	0.99	0.99
<b>Multi Crop Separator</b>				
Width / Diameter (mm)	-	1340 / 600	-	1600 / 600
<b>Separator concave</b>				
No. of bars	8	8	8	8
Area (m <sup>2</sup> )	-	0.9	-	1.07
Rotating concave system	-	●	-	●
<b>Straw walkers</b>				
No. / No. of steps	5 / 4	5 / 4	6 / 4	6 / 4
Separation area (m <sup>2</sup> )	5.73	5.73	6.81	6.81
<b>Shaker shoe</b>				
Grain pan with high dividers	●	●	●	●
Top and bottom electrical adjustable sieves	○	○	○	○
Total area (m <sup>2</sup> )	4.67	4.67	5.81	5.81
Full width volumetric blade type fan	●	●	●	●
Fan speed rev/min	350 to 1050	350 to 1050	350 to 1050	350 to 1050
Returns to cylinder	●	●	●	●
Fan speed adjustment, electrical, in cab	●	●	●	●
<b>Grain tank</b>				
Capacity (litres)	8600	8600	8600	8600
Unloading rate (l/sec)	85	105	85	105
Auger length (m)	5.0	5.0	5.0	5.0
Unloading height (m)	4.5	4.5	4.5	4.5

- Not available ● Standard specification ○ Optional

	ACTIVA S 7345	ACTIVA S 7345 MCS	ACTIVA S 7347	ACTIVA S 7347 MCS
<b>Residue handling</b>				
Straw chopper	•	•	•	•
<b>** Engine</b>				
AGCO POWER Selective Catalytic Reduction (SCR)	•	•	•	•
Capacity (litres)	7.4	7.4	7.4	7.4
Power (ISO 14396) hp/kW	243/179	243/179	276/203	276 / 203
*with Power Boost			306*/225	306*/225
Fuel tank capacity (litres)	620	620	620	620
AdBlue (litres)	80	80	80	80
<b>Transmission</b>				
Hydrostatic / 4 gears	•	•	•	•
<b>Tyres</b>				
Front	650/75 R 32	650/75 R 32	650/75 R 32	650/75 R 32
Rear	460/70 R 24	460/70 R 24	460/70 R 24	460/70 R 24
<b>Cab</b>				
	Heater, air conditioning, electrically controlled view mirrors, air suspended seat, 3D steering column, TechTouch 2 terminal			
<b>Dimensions</b>				
Overall length without table (mm)	9070	9070	9070	9070
Width without table, standard tyres (mm)	3280	3280	3560	3560
Weight (kg)	12500	12800	12930	13280

\*\* (low regulation fuel versions available)

## Options

	ACTIVA S 7345	ACTIVA S 7345 MCS	ACTIVA S 7347	ACTIVA S 7347 MCS
<b>Residue handling</b>				
Straw chopper hood with electrical deflectors	○	○	○	○
Chaff spreader	○	○	○	○
<b>Option Tyres</b>				
Front	800/65 R 32	800/65 R 32	800/65 R 32	800/65 R 32
Front	710/75 R 32	710/75 R 32	800/65 R 32	800/65 R 32
Rear	540/65 R 24	540/65 R 24	540/65 R 24	540/65 R 24
Front below 3.5 m	800/65 R 32	800/5 R 32	650/75 R 32	650/75 R 32
Rear below 3.5 m	540/65 R 24	540/65 R 24	460/70 R 24	460/70 R 24
High performance top sieve for maize	○	○	○	○
Fan speed reduction (270 to 840 rev/min)	○	○	○	○
<b>Accessories</b>				
	4WD rear axle multimedia system with navigation, maize kit, air compressor, pea and bean kit			

Every effort has been made to ensure that the information contained in this publication is as accurate and current as possible. However, inaccuracies, errors or omissions may occur and details of the specifications may be changed at any time without notice. Therefore, all specifications should be confirmed with your Massey Ferguson Dealer or Distributor prior to any purchase.

# Built to meet the demands of the toughest harvests

## Cab

Comfortable, spacious cab with TechTouch 2 Terminal which is mounted to the drivers seat, for monitoring/adjustment of combine settings at the touch of a button.

## PowerFlow header

Active crop flow for continuous feed to the threshing cylinder in all conditions.

## Power Feed roller

Ensures continuous feed across the full width of the crop elevator for high outputs and excellent threshing quality.

## Threshing cylinder

High inertia threshing cylinder with ballast bars delivers high performance even in tough conditions.

## Grain Tank

Grain tank with electrically operated grain tank lids and high capacity for long runs in the field

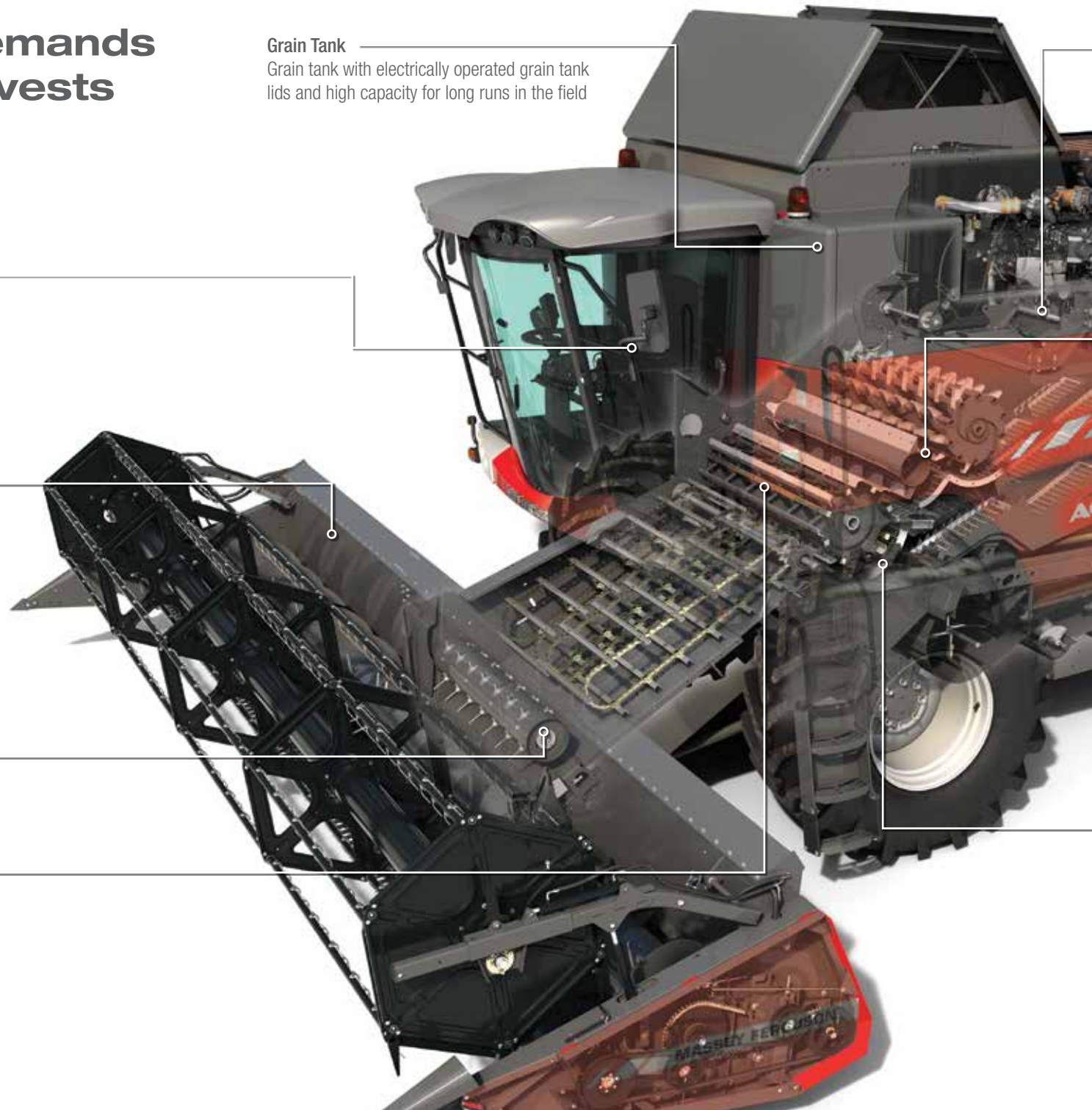



### **Engine**

Powerful AGCO POWER 6-cylinder engine with SCR technology for excellent fuel efficiency and cleaner emissions.  
(low regulation fuel versions available)

### **Multi Crop Separator Plus**

Increased active grain separation in tough conditions. Uniquely the MCS Plus concave can be swivelled over the top to maintain good straw quality in dry conditions.

### **Straw walkers**

4.2 m long straw walkers with high and permeable straw walker steps for improved separation.

### **Straw chopper**

Multi adjustable serrated blade chopper for excellent chopping quality with low power requirement giving an even spread of material over the entire table working width.

### **Shaker shoe**

Long grain pan with high dividers and 'High Capacity' sieves offer a very clean grain sample.

### **Heavy duty concave**

Independent front and rear setting of concave clearance facilitates optimal adjustment for best threshing results in any condition and crop (optional Sectional, Universal and Maize concave).



# MASSEY FERGUSON

**A world of experience. Working with you.**



Web: [www.MasseyFerguson.com](http://www.MasseyFerguson.com)

Facebook: [www.Facebook.com/MasseyFergusonGlobal](http://www.Facebook.com/MasseyFergusonGlobal)

Twitter: [Twitter.com/MF\\_EAME](http://Twitter.com/MF_EAME)

Instagram: [Instagram.com/MasseyFergusonGlobal](http://Instagram.com/MasseyFergusonGlobal)

YouTube: [www.YouTube.com/MasseyFergusonGlobal](http://www.YouTube.com/MasseyFergusonGlobal)

Blog: [Blog.MasseyFerguson.com](http://Blog.MasseyFerguson.com)

 **MASSEY FERGUSON**® is a worldwide brand of AGCO.  
© AGCO Limited. 2015 | 15885/0715 | A-English/0715/6m



Responsible forest management

